

A	B	C (mm)		D
1	L74-0001 A	2014	501	2/4
2	L74-0002	918	360	3/4
3	L74-1001	820	840	1/4
4	L74-1002	820	840	1/4
5	L74-4001	780	335	3/4
6	L74-4003	780	335	3/4
7	L74-4004	1956	360	2/4
8	L74-4005	780	92	3/4
9	L74-4006	614	100	2/4
10	L74-4007	2000	490	2/4
11	L74-5001	630	200	1/4
12	L74-5002	630	200	3/4
13	L74-5003	817	200	1/4
14	L74-7005	1990	25	2/4
15	L74-7006	809	60	4/4
16	L74-7007	1990	25	2/4
17	L74-7008	817	65	4/4
18	L74-9001	828	627	1/4
19	n215	2000	50	2/4

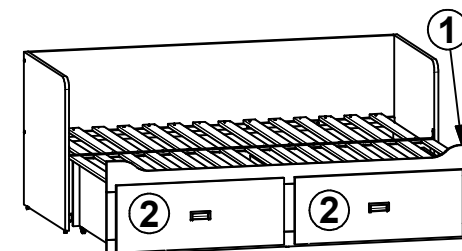

2x 96 mm c468	8x Ø7x50 mm e1	22x Ø6,3x13 mm e2	46x Ø8x30 mm f1	10x M6x60 mm j144	6x k34	4x M6/Ø14x14 mm k3912	4x M6/22 mm k3913	16x l2	2x 55x30x2012 n100	2x 42x40x14.5/1.5 mm n105	42x Ø4x35 mm p26	6x Ø3,5x15 mm p51
4x Ø4x12 mm p59	14x Ø4x40 mm p64	12x Ø4x20 mm p68	24x Ø3,5x12 mm p140	18x Ø15x12 mm #16 r1	10x Ø10x13 mm r511	18x 20/11 r42	4x 500/820 mm w16511	4x 500/820 mm w16512	8x Ø16 s2	1x 4 mm z1		

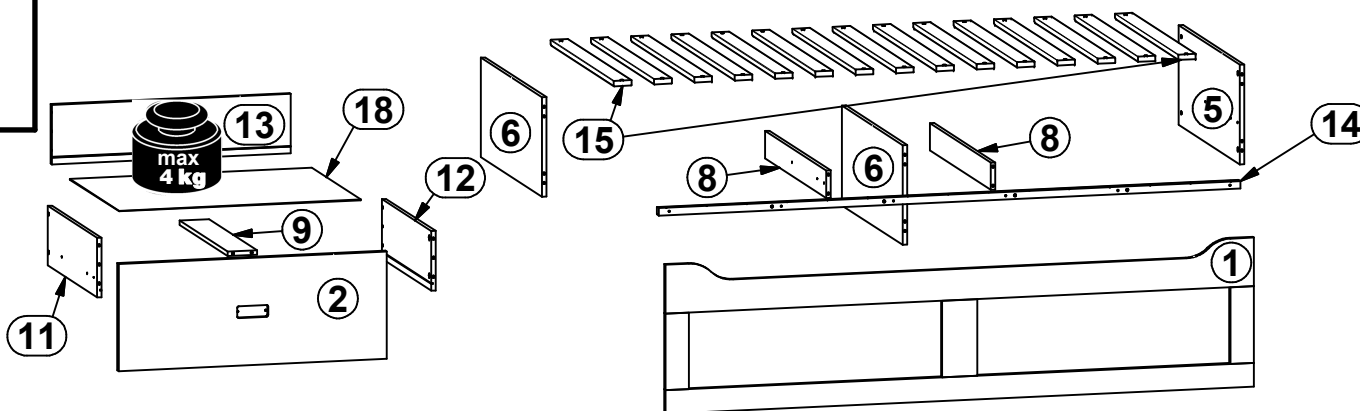
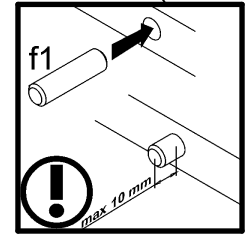
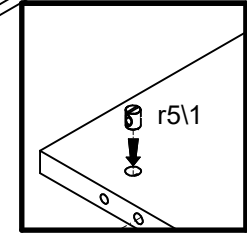
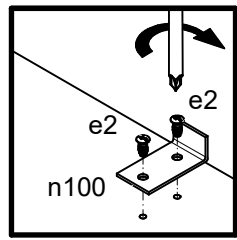
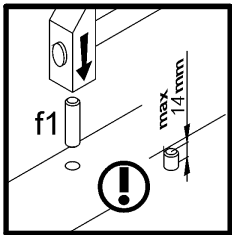
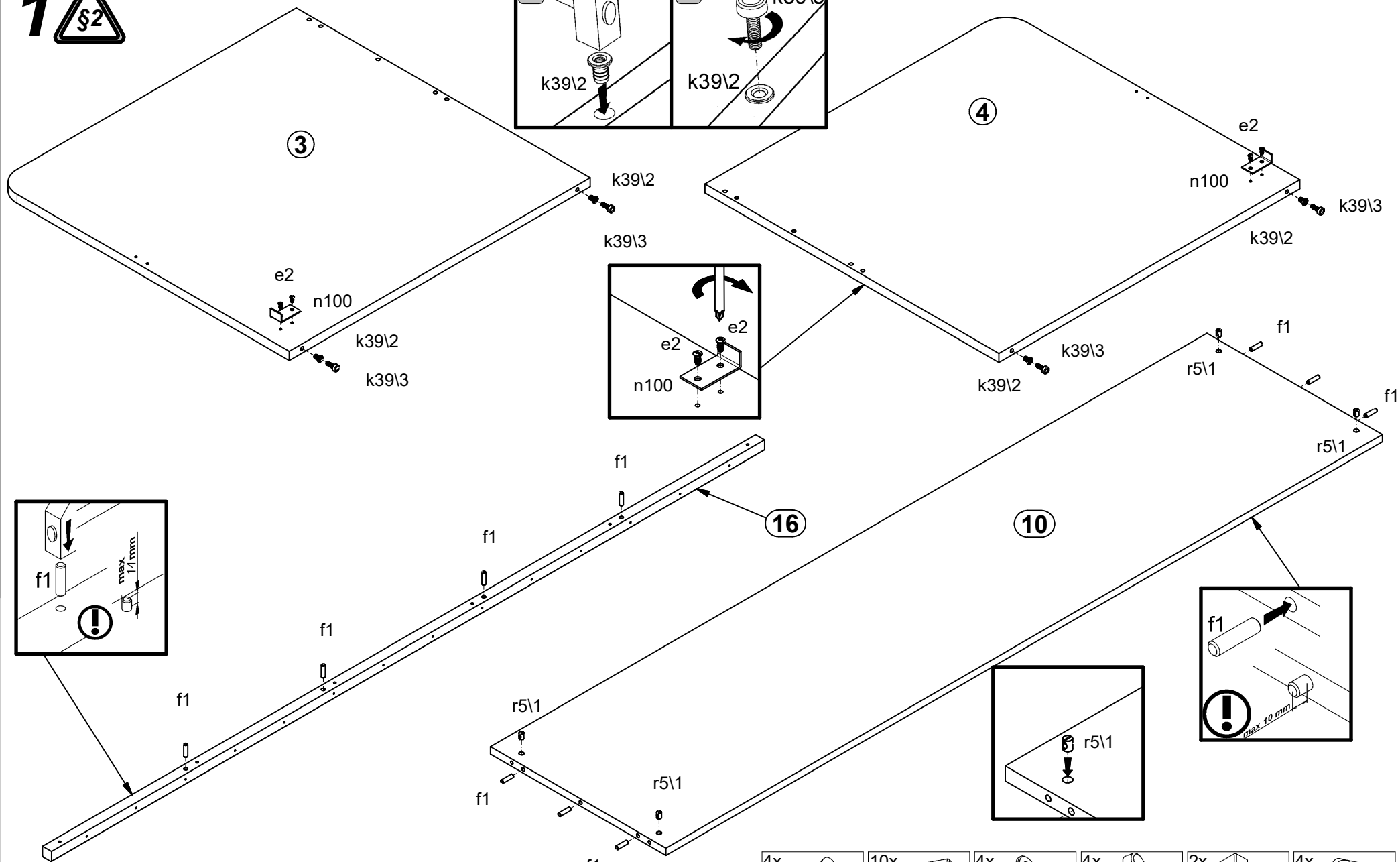
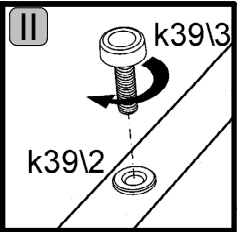
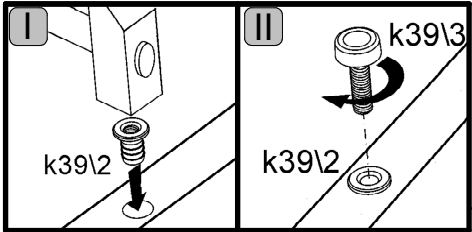

4x Ø6,3x13 mm e2	10x Ø8x30 mm f1	4x M6/Ø14x14 mm k39\2	4x M6/22 mm k39\3	2x 55x30x20\2 n100	4x Ø10x13 mm r5\1
------------------------	-----------------------	-----------------------------	-------------------------	--------------------------	-------------------------

2 §6

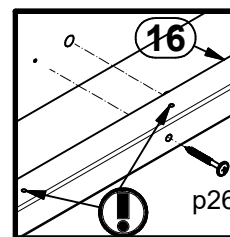
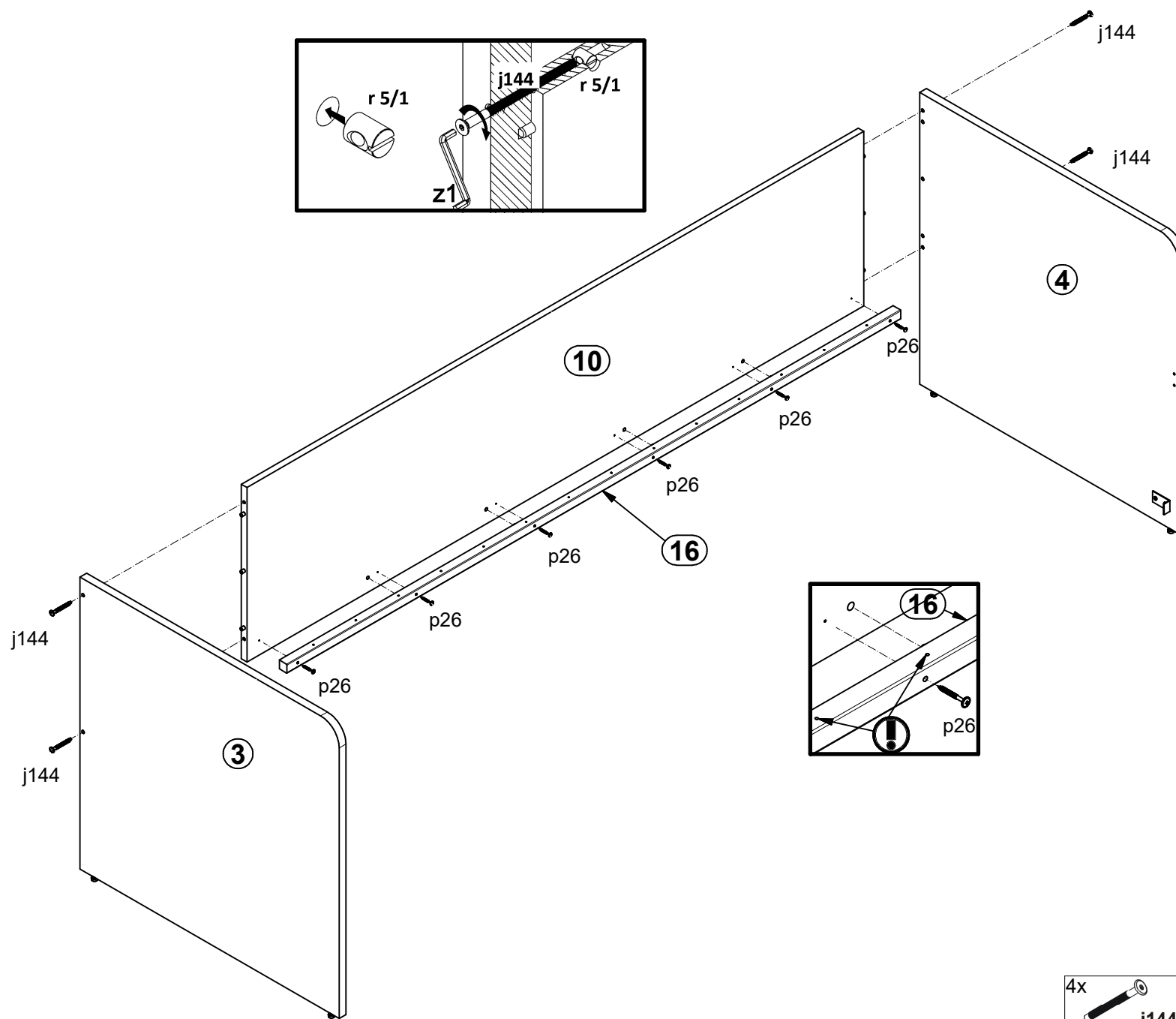
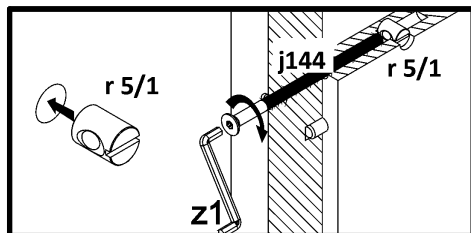



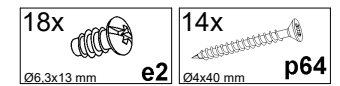
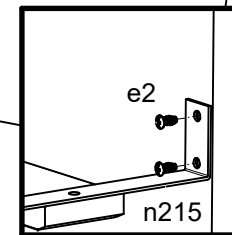
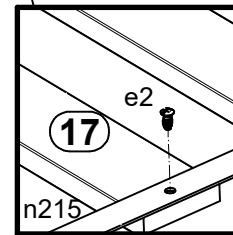
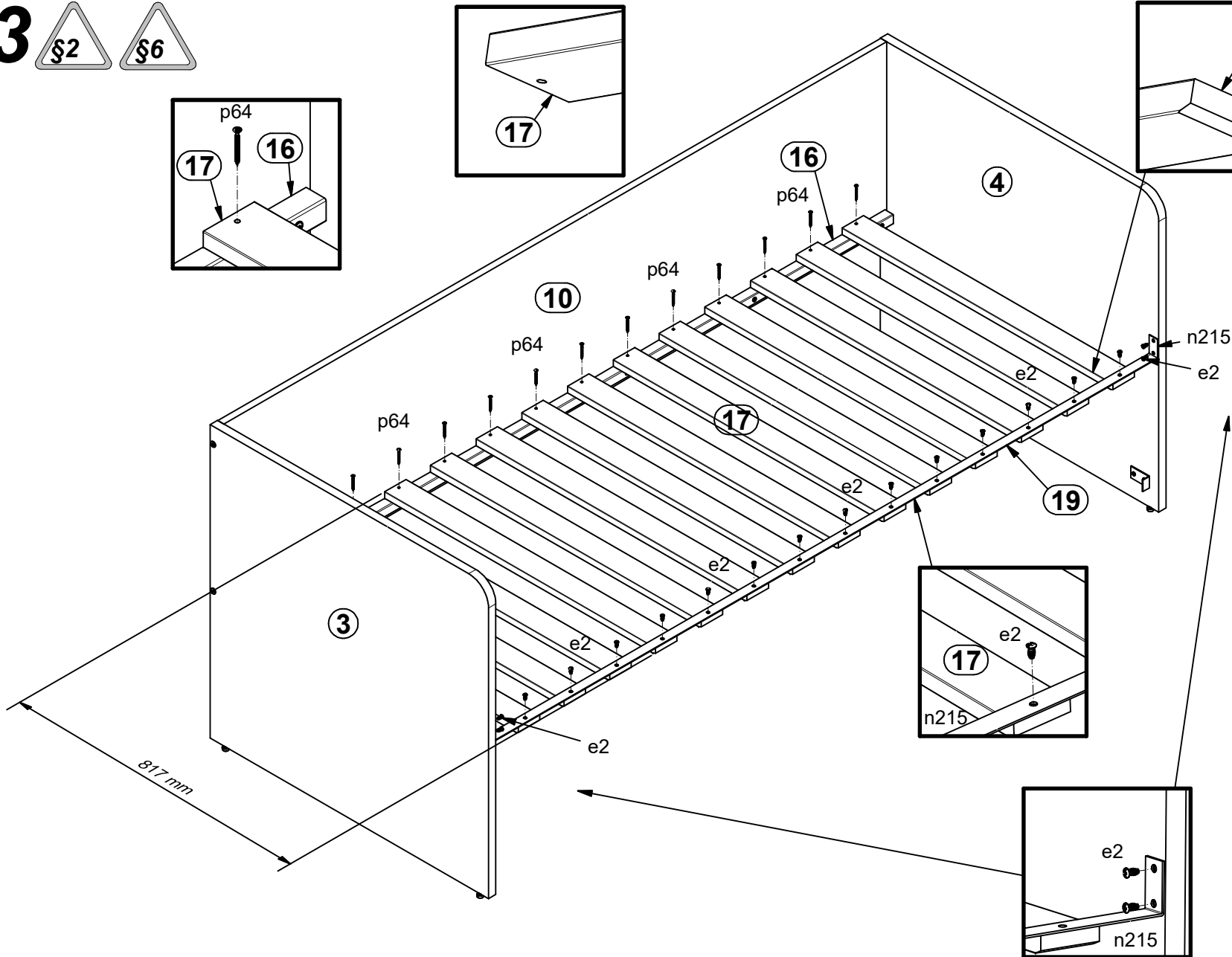
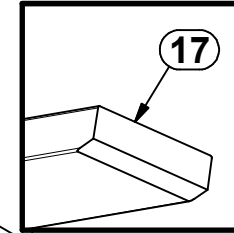
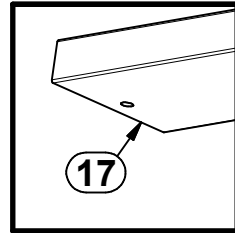
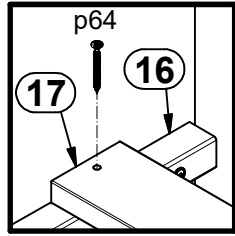

3

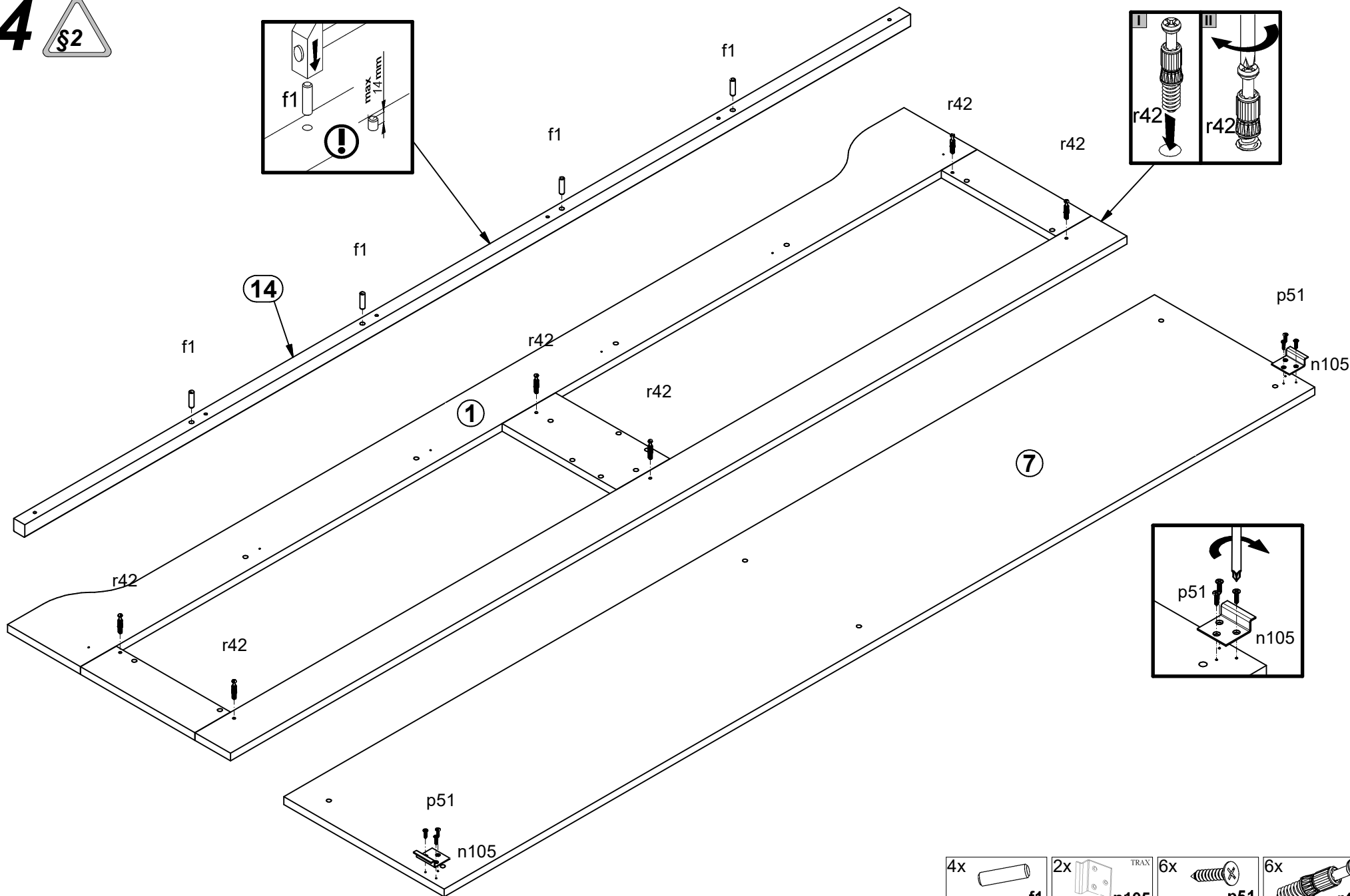
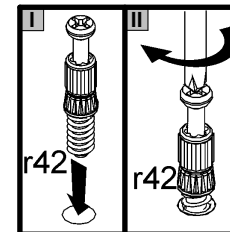
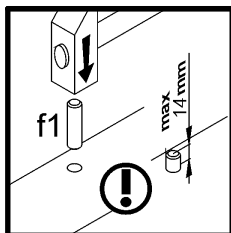

4 



- 4x  f1 Ø8x30 mm
- 2x  n105 42x40x14.5/1.5 mm
- 6x  p51 Ø3.5x15 mm
- 6x  r42 20/11

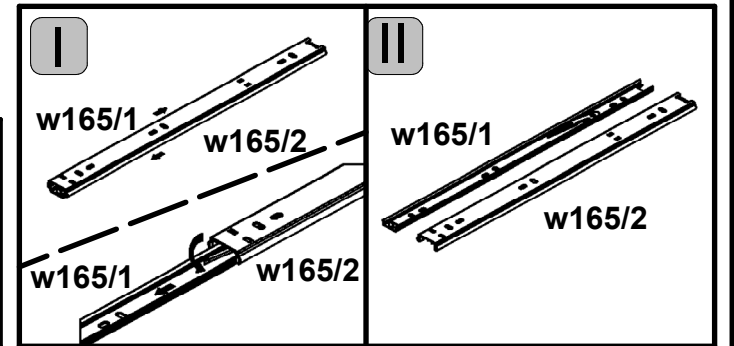
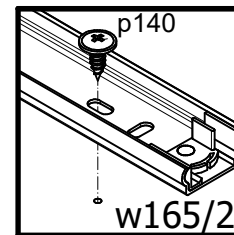
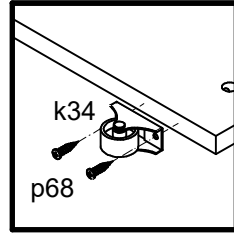
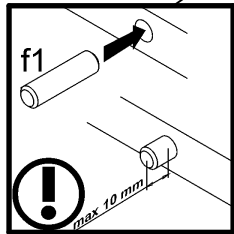
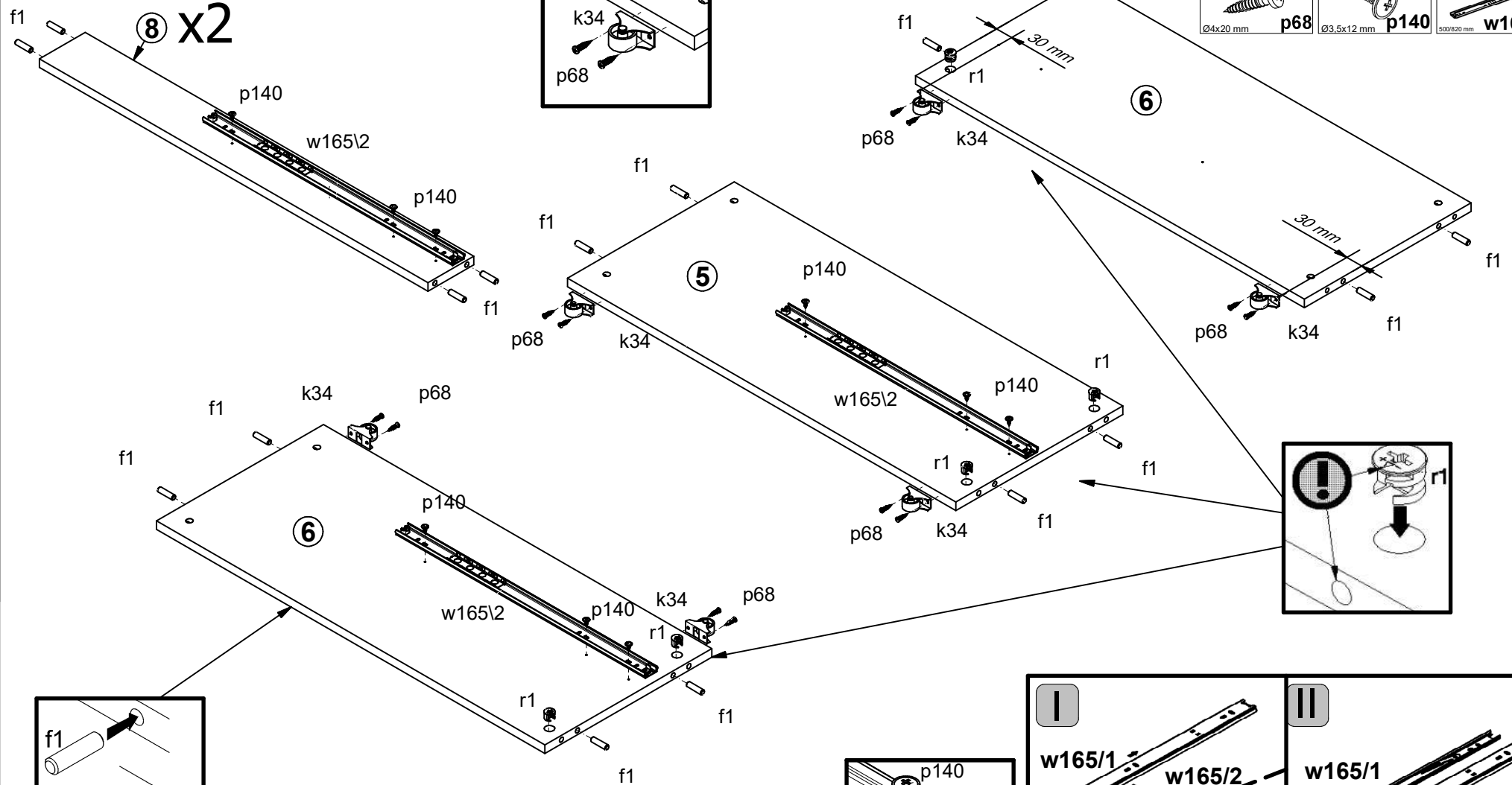

5 

20x Ø8x30 mm f1	6x k34	6x Ø15x12 mm #16 r1
12x Ø4x20 mm p68	12x Ø3.5x12 mm p140	4x 500/920 mm w165/2

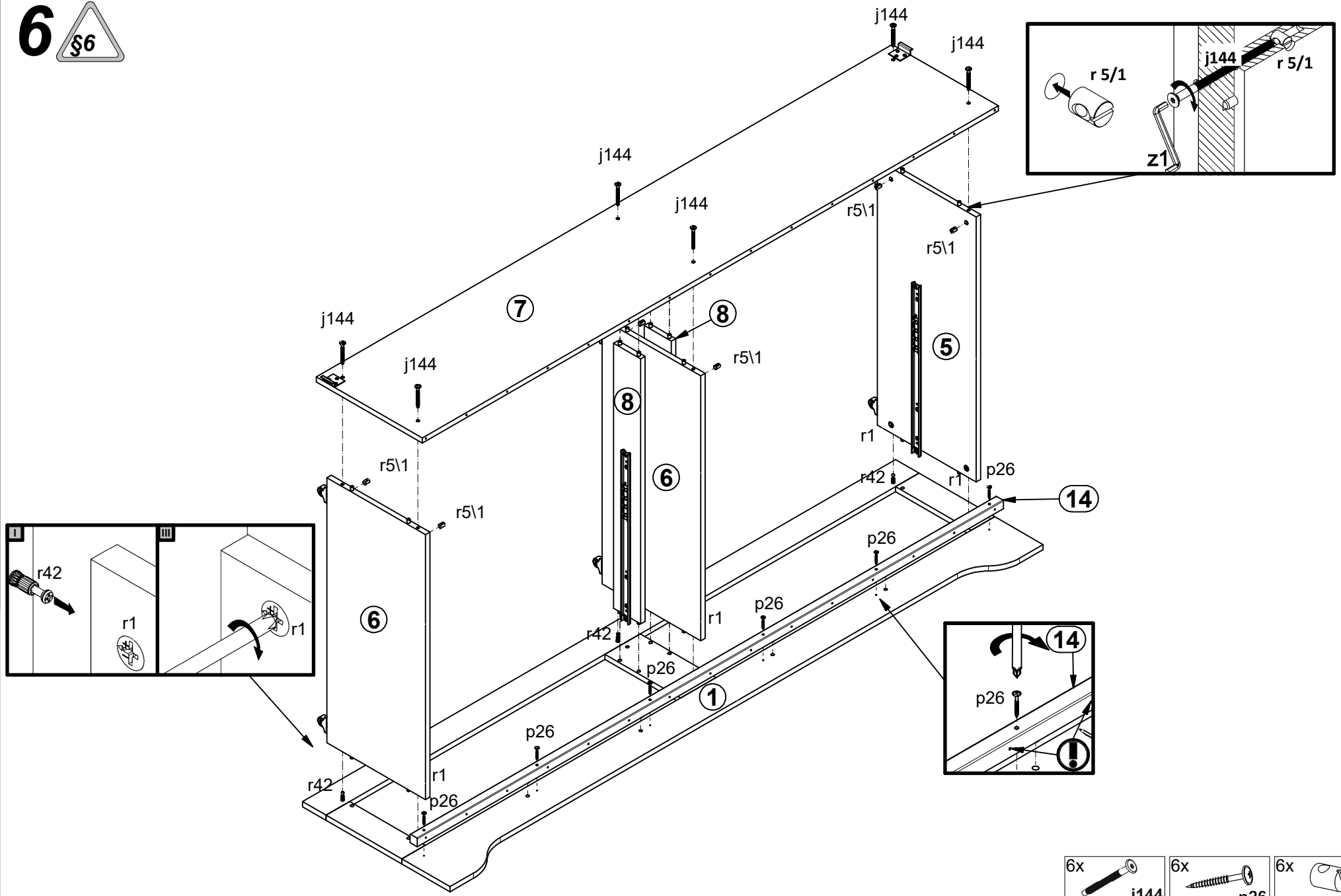

6 



- 6x  **j144**
M6x60 mm
- 6x  **p26**
Ø4x35 mm
- 6x  **r5/1**
Ø10x13 mm



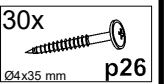
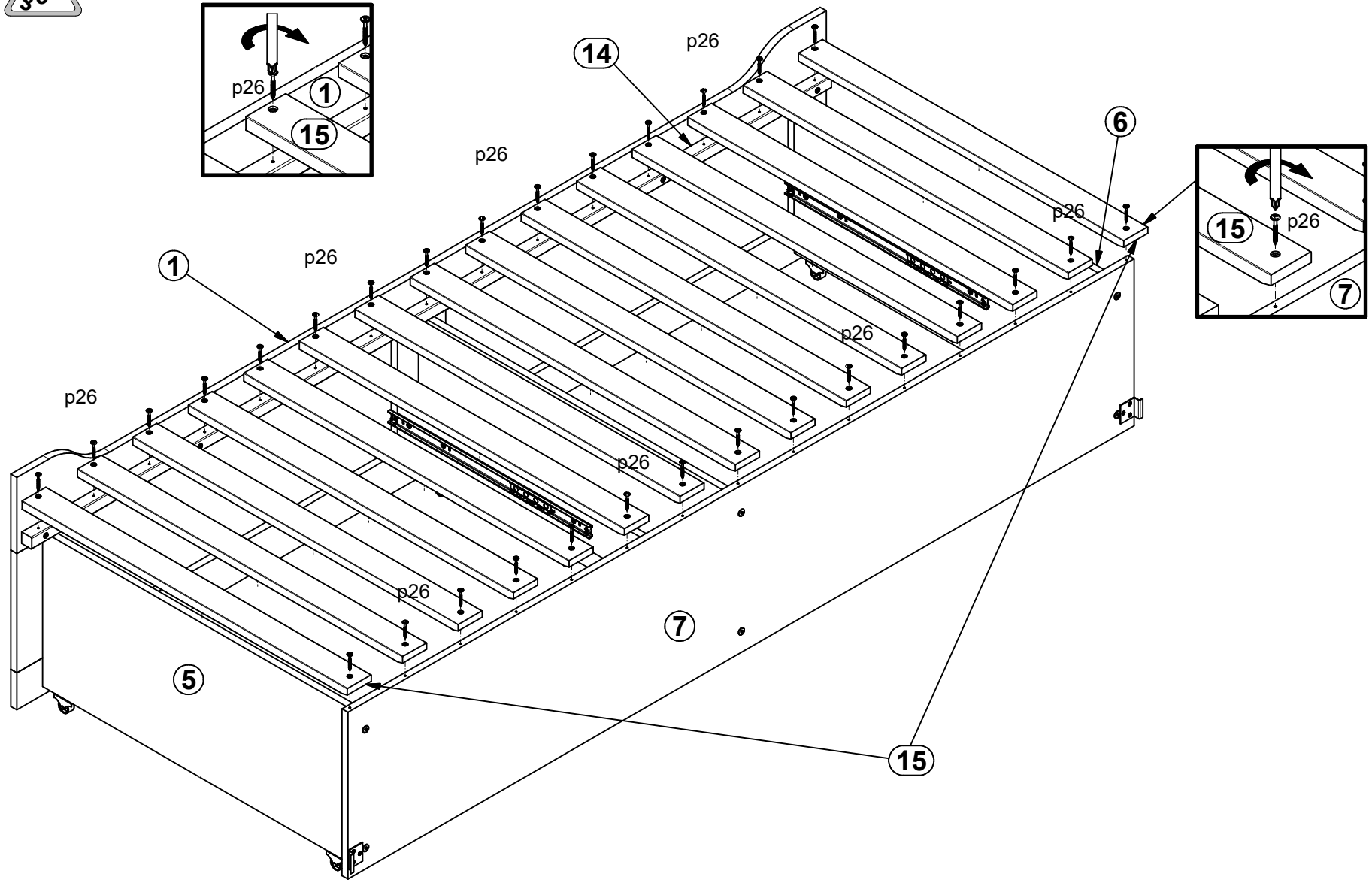



7  

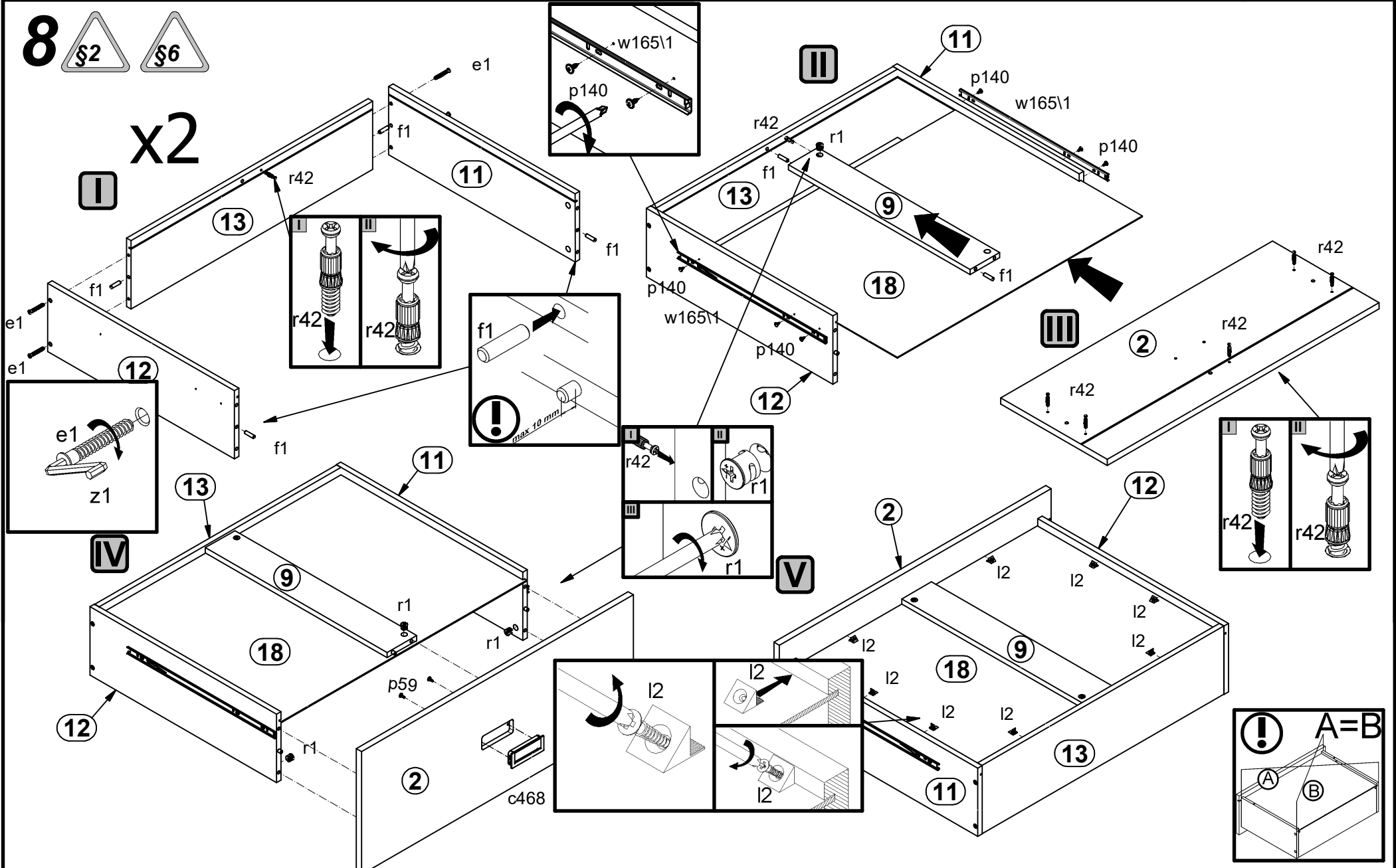

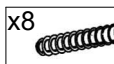
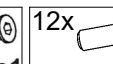
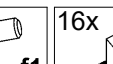
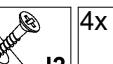
8  

x2



- 2x  c468 96 mm
- x8  e1 $\varnothing 7 \times 50$ mm
- 12x  f1 $\varnothing 8 \times 30$ mm
- 16x  l2 $\varnothing 4 \times 12$ mm
- 4x  p59 $\varnothing 3.5 \times 12$ mm
- 12x  p140 $\varnothing 15 \times 12$ mm #16
- 12x  r1 $\varnothing 15 \times 12$ mm #16
- 12x  r42 $\varnothing 15 \times 12$ mm #16
- 4x  w165\1 300/820 mm
- 1x  z1 4 mm

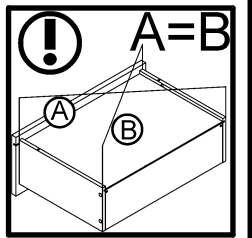

9

